Thank you for purchasing this AgfaPhoto digital camera. Please read these operating instructions carefully in order to use the digital camera correctly. Keep the instructions in a safe place after reading so that you can refer to them later.

Precautions

- Do not aim the camera directly into the sun or other intense light sources which could damage your eyesight.
- Do not try to open the case of the camera or attempt to modify this camera in any way. High-voltage internal components create the risk of electric shock when exposed. Maintenance and repairs should be carried out only by authorized service providers.
- Do not press the flash too close to the eyes of animals or young children. Eye damage may result. Please remain at least one meter away from infants when using flash.
- Keep the camera away from water and other liquids. Do not use the camera with wet hands. Never use the camera in the rain or snow. Moisture creates internal danger and may cause electric shock.
- Keep the camera and its accessories out of the reach of children and animals to prevent accidents or damage to the camera.
- If you notice smoke or a strange odor coming from the camera, turn the power off immediately. Take the camera to the nearest authorized service center for repair. Never attempt to repair the camera on your own.
- Use only the recommended power accessories. Use of power sources not expressly recommended for this equipment may lead to overheating, distortion of the equipment, fire, electrical shock or other hazards.

Disclaimer

We assume no responsibility over and above the provisions of the Product Liability Law for damages suffered by the user or third parties as a result of inappropriate handling of the product or its accessories, or by their operational failure and by their use. We reserve the right to make changes to this product and its accessories without prior notice.

Warning!

Never disconnect to open the camera or remove any parts of it. This will invalidate all guarantee claims.

Using your batteries

For best performance and prolonged battery life, we recommend the use of AA lithium or rechargeable NiMH batteries.

Extending battery life

The following functions use up a great deal of battery power and should therefore only be used occasionally:

-
- Excessive use of flash
 - Editing images on the camera display

The battery life can be affected by soiling. Please clean the contacts with a clean and dry cloth before putting the batteries in the camera. Battery performance drops at temperatures below 5°C (41 °F). If you use the camera at low temperatures you should have replacement batteries to hand and ensure they do not get too cold. Please note: you should not dispose of cold and seemingly flat batteries because these batteries may work again at room temperature.

Contents

<u>GETTING STARTED</u>	1	USING THE SELF-TIMER & BURST	25
USING THIS MENU	1	RECORDING MOVIE CLIPS	26
CONTENT	2	SETTING THE MOVIE SIZE	26
PARTS OF THE CAMERA	3	RECORDING AUDIO CLIPS	27
INSERTING THE BATTERIES	5	PLAYING BACK AUDIO CLIPS	27
LOW BATTERY INDICATOR	5	RECORDING A VOICE MEMO	28
ABOUT BATTERY TYPE	5	PLAYING BACK A VOICE MEMO	28
INSERTING THE MEMORY CARD	6	<u>OTHER RECORDING FUNCTIONS</u>	29
ABOUT CAMERA MEMORY	6	SETTING THE METERING	29
DCF PROTOCOL	6	SETTING THE WHITE BALANCE	29
SETTING THE DISPLAY LANGUAGE / DATE &		SETTING THE ISO	30
TIME	7	SETTING THE EXPOSURE	30
SETTING THE DISPLAY LANGUAGE	7	SETTING THE AEB	30
SETTING THE DATE & TIME	7	SETTING THE HIGHLIGHT	30
USING THE LCD MONITOR	9	SETTING THE SHARPNESS	31
REC MODE	9	SETTING THE PHOTO EFFECT	31
PLAYBACK MODE	10	SETTING DATE STAMP	31
CHANGING THE LCD STATUS	11	<u>PLAYBACK</u>	32
<u>BASIC OPERATION</u>	12	PLAYBACK IMAGES	32
TURNING THE POWER ON AND OFF	12	PLAYING BACK MOVIE CLIPS	32
POWER SAVING FUNCTION	12	MAGNIFYING & TRIMMING STILL IMAGES	33
CHANGING THE MODE	13	VIEWING IN THUMBNAIL	34
SWITCHING BETWEEN REC MODE AND		PLAYING A SLIDE SHOW	34
PLAYBACK MODE	13	DELETING FILES	35
SELECTING THE REC MODE	13	DELETING A SINGLE FILE	35
USING THE MENUS	15	DELETING MULTIPLE FILES	36
REC MENU	15	DELETING ALL FILES	36
SETUP MENU	16	PROTECTING A SINGLE FILE	37
<u>BASIC RECORDING</u>	19	PROTECTING ALL FILES	37
RECORDING STILL IMAGES	19	PROTECTING MULTIPLE FILES	38
USING THE Q MODE	20	EDITING IMAGES	39
SETTING IMAGE SIZE AND QUALITY	21	ROTATING STILL IMAGES	39
USING THE ZOOM FUNCTION	22	CHANGING THE IMAGE SIZE	39
USING THE FLASH	23	CHANGING THE IMAGE WITH EFFECTS	40
USING THE MACRO	24	COPYING THE FILES	41
		SETTING THE DPOF	42

CHOOSING A STARTUP IMAGE 43

MAKING CONNECTIONS 44

CONNECTING THE CAMERA TO A TV 44

CONNECTING THE CAMERA TO A PC 45

USING THE CARD READER 45

CONNECTING THE CAMERA TO A
COMPUTER WITH THE USB CABLE 45

APPENDIX 46

ABOUT THE FOLDER & FILE NAME 46

FOLDER STRUCTURE 46

FILE NAMING 46

TROUBLESHOOTING 47

SPECIFICATIONS 48

FUNCTION AVAILABLE LIST 49

CUSTOMER CARE 52

**DISPOSAL OF WASTE EQUIPMENT BY
USERS IN PRIVATE HOUSEHOLDS IN THE**

EUROPEAN UNION 52

FCC COMPLIANCE AND ADVISORY 53

Getting Started

Using This Menu

Getting Started

This section contains information you should know before using this camera.

Basic Operation

This section explains all recording features of this camera.

Basic Recording

This section explains how to record still images, movies, and audio files.

Other Recording Functions

This section explains common operations about recording images.

Playback

This section explains playback, delete, and edit functions of still images, movies and audio files.



Making Connections

This section tells you how to connect this camera to a computer or TV.

Appendix

This section describes the troubleshooting and the camera specification.

The meanings of the symbols used in this user's manual are explained below:

 Caution	This indicates cautions that should be read before using these functions.
 Tips	This indicates the useful information when using this camera.
	This indicates the reference page.

Content

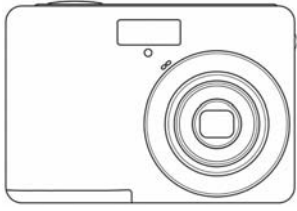

AgfaPhoto DC-830i

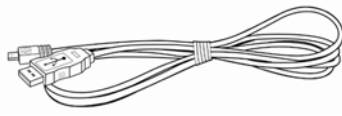

USB Cable

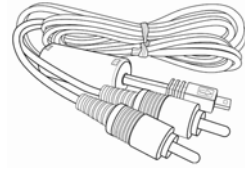

AV Cable

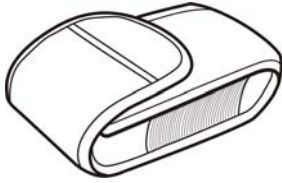

Soft Case



Strap

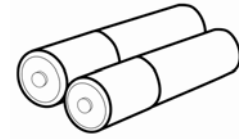

2 x AA Batteries

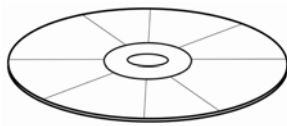

Software Installation
CD-ROM

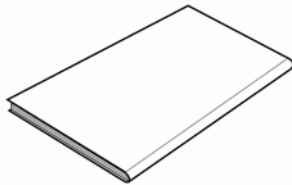

Quick Start Guide



Caution

- Do not swing the camera around by the strap.

Parts of the Camera

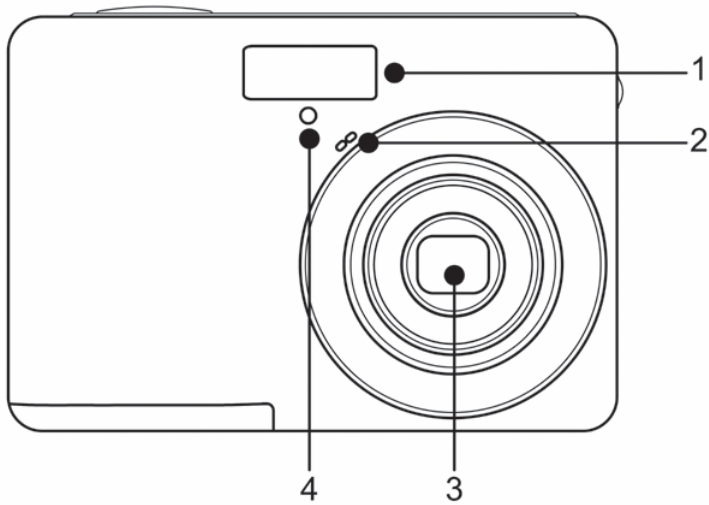

1. Flash (👉 page 23)
2. Self-timer Lamp
3. Lens
4. Microphone

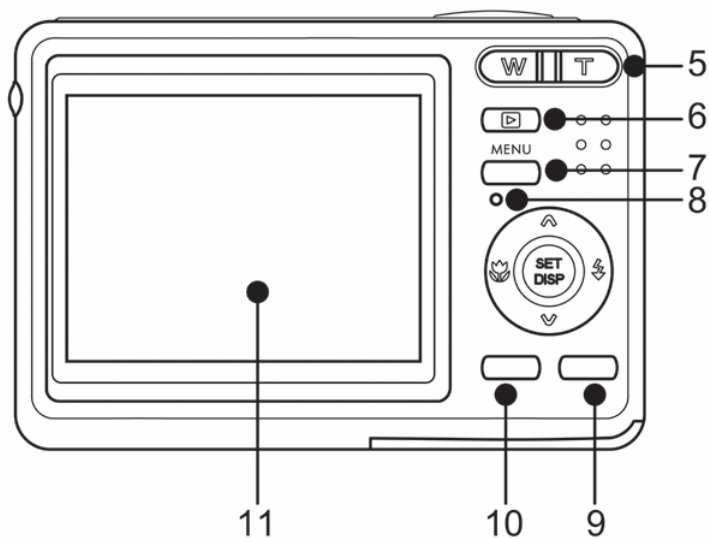

5. Zoom Button (👉 page 22)
 - Thumbnail (👉 page 34)
 - Playback Zoom (👉 page 33)
6. Playback Button (👉 page 13)
7. Menu Button (👉 page 15)
8. Operation Lamp
9. Mode Button (👉 page 13)
10. Delete Button (👉 page 35)
11. LCD Monitor (👉 page 9)

Four-way Control

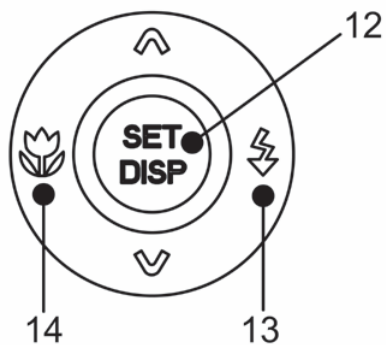

12. SET/DISP Button (👉 page 11)
13. Flash Button (👉 page 23)
14. Macro Button (👉 page 24)

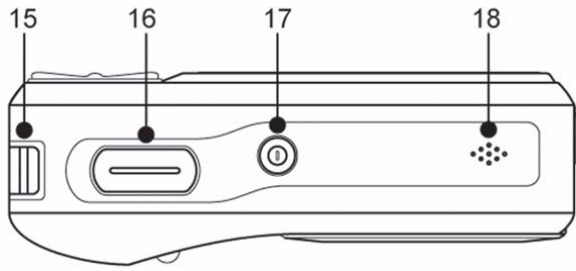

- 15. Strap Ring
- 16. Shutter Button
(☞ page 19, 26)
- 17. Power Button (☞ page 12)
- 18. Speaker

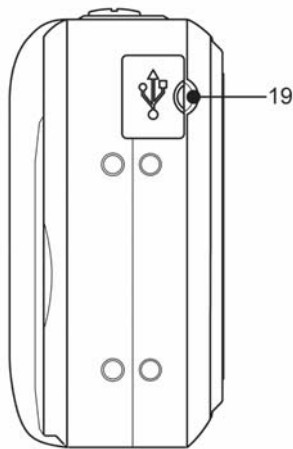

- 19. USB/AV Terminal
(☞ page 18, 45)

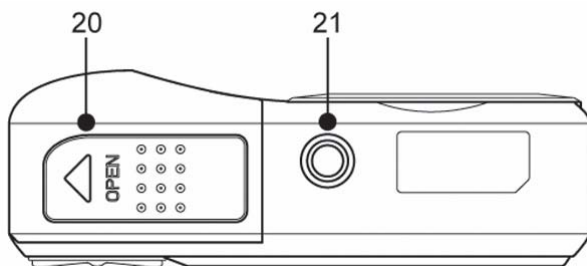

- 21. Battery Cover (☞ page 5)
- 22. Tripod Socket

Inserting the Batteries

The camera is powered by two AA-size alkaline batteries or rechargeable NiMH batteries.

1

Open the battery cover.

- Slide the battery cover in the direction indicated by the arrow.

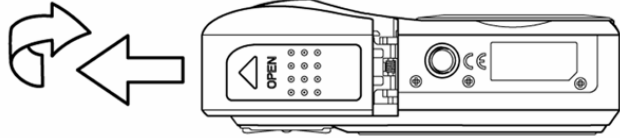

2

Insert the batteries.

- Insert two AA-size batteries with the positive (+) and negative (-) poles matching the directions indicated inside the battery room.

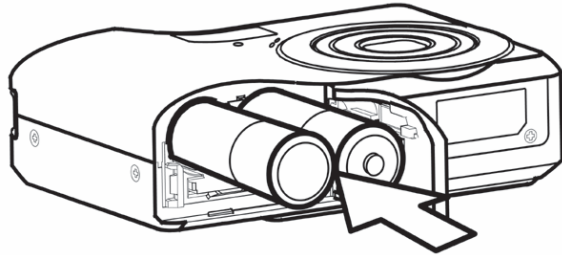

3

Close the battery cover.

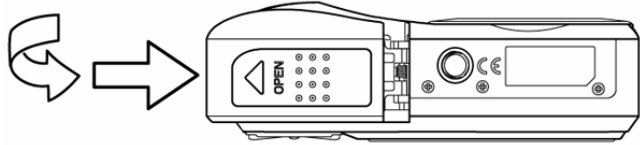

Low Battery Indicator

A low battery indicator  appears on the LCD screen when the batteries are nearly exhausted. Batteries should be replaced promptly when the low battery indicator appears.



Caution

- Risk of explosion if battery is replaced by an incorrect type dispose of used batteries according to the instructions.
- Be sure to turn off the camera power before insert or remove batteries.
- Use only Alkaline or NiMH battery to power this camera. Use of any other type battery is not recommended.
- Replace all batteries at the same time. Never mix old and new batteries.
- Remove batteries if you will not be using them for a long time.
- The camera body may feel warm after extended use. This is normal.

About Battery Type

After replacing the batteries, please check the Battery Type in the setup menu ( page 18).

Inserting the Memory Card

You can use SD Card with this digital camera. The memory card slot is located beneath the battery cover, adjacent to the battery compartment.

1

Open the battery cover.

- Slide the battery cover in the direction indicated by the arrow.

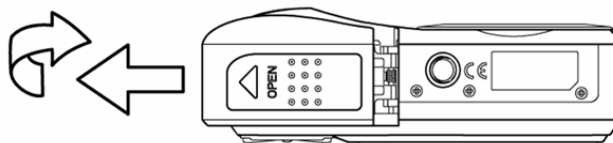

2

Insert the card.

- Insert the card with the label facing up and the arrow pointing in.

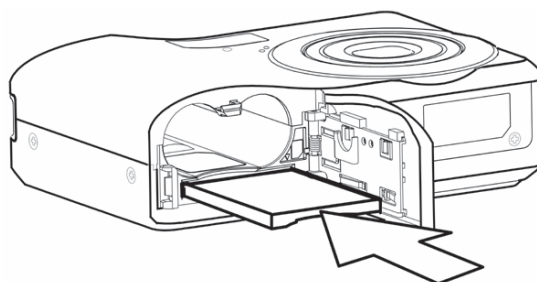

?

Tips

- To remove the card, gently press on the edge of the card and release it. Pull the card out and close the battery cover.

3

Close the battery cover.

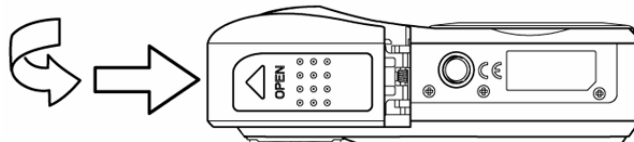

!

Caution

- It may cause damage to the card if removed while the camera is on.
- Do not touch the connection terminals on the back side of the card.

About Camera Memory

This camera is equipped with internal memory. If the memory card is not inserted in the camera, all images and movie clips recorded by the camera will be stored in the internal memory. If the memory card is inserted, images and movie clips are stored on the memory card.

DCF Protocol

The DCF protocol defines the format for image file data as well as the directory structure for the memory card. Images that are taken by a DCF camera can be viewed on DCF-compatible cameras from other manufacturers.

Setting the Display Language / Date & Time

When using the camera for the first time after purchasing, be sure to choose a language and set the date & time before using the camera.

Setting the Display Language

1 Turn the power on, and set the camera to the Setup Menu (☞ page 16).

2 Select [🗨️ Language].

- Press ▲ or ▼ to select [LANGUAGE] then press ▶ or the SET button to launch the submenu.



3 Select a language.

- Press ▲ or ▼ to select a language and press ◀ or the SET button to apply the setting.

4 Press the MENU button to close the menu.

Setting the Date & Time

1 Turn the power on, and set the camera to the Setup Menu (☞ page 16).

2 Select [📅 Date & Time].

- Press ▲ or ▼ to select [Date & Time] then press ▶ or the SET button to launch the submenu.



3 Set date and time.

- Press ▲ or ▼ to change the value of the cursor located. Press ◀ or ▶ to move the cursor between settings.

? Tips

- Holding down ▲ or ▼ changes the values continuously.
- For date stamp setting (☞ page 31).

4

Apply the setting.

- After adjusting the settings, press the **SET** or the **MENU** button to apply the setting.



Caution

- If the batteries are removed for longer than 48 hours, the Date and Time will need to be re-set.

Using the LCD Monitor

The LCD monitor is used to compose images while recording, adjust settings and replay images. The following indicators may appear on the LCD monitor while recording or playing back images.

REC mode

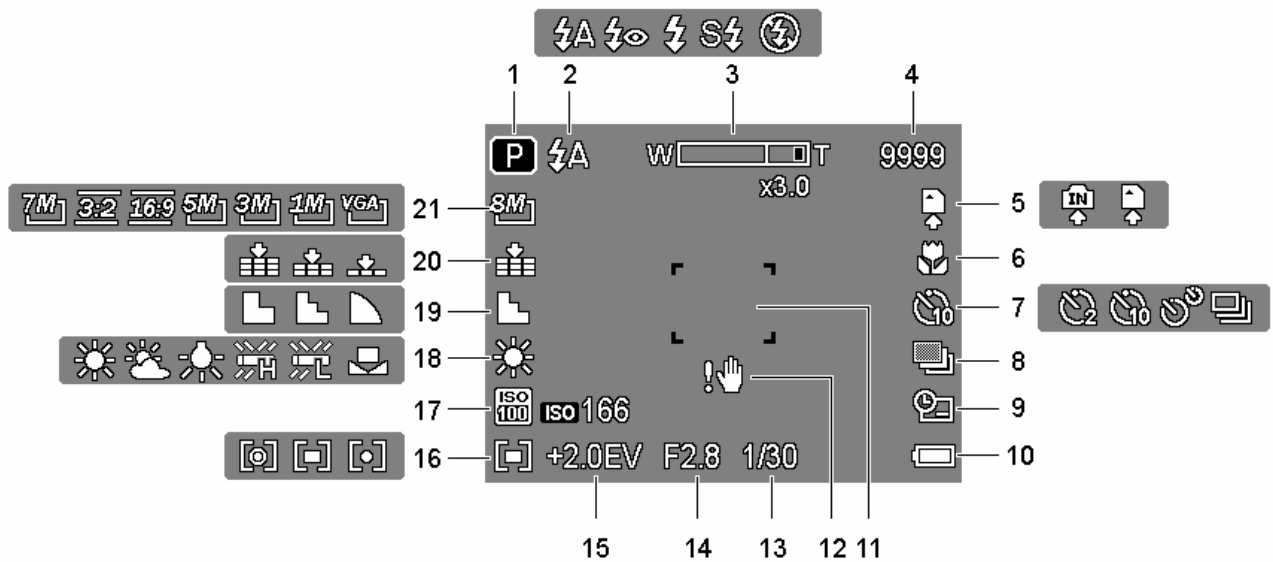

- | | | | |
|----|--------------------------------|----|----------------------------|
| 1 | Recording mode (☞ page 13) | 12 | Shake warning (☞ page 19) |
| 2 | Flash (☞ page 23) | 13 | Shutter speed (☞ page 19) |
| 3 | Zoom indicator (☞ page 22) | 14 | Aperture value (☞ page 19) |
| 4 | Shots remaining | 15 | Exposure (☞ page 30) |
| 5 | Storage media | 16 | Metering (☞ page 29) |
| 6 | Macro (☞ page 24) | 17 | ISO (☞ page 30) |
| 7 | Self-timer / Burst (☞ page 25) | 18 | White balance (☞ page 29) |
| 8 | AEB (☞ page 30) | 19 | Sharpness (☞ page 31) |
| 9 | Date stamp (☞ page 31) | 20 | Quality (☞ page 21) |
| 10 | Battery (☞ page 5) | 21 | Resolution (☞ page 21) |
| 11 | Focus area (☞ page 19) | | |

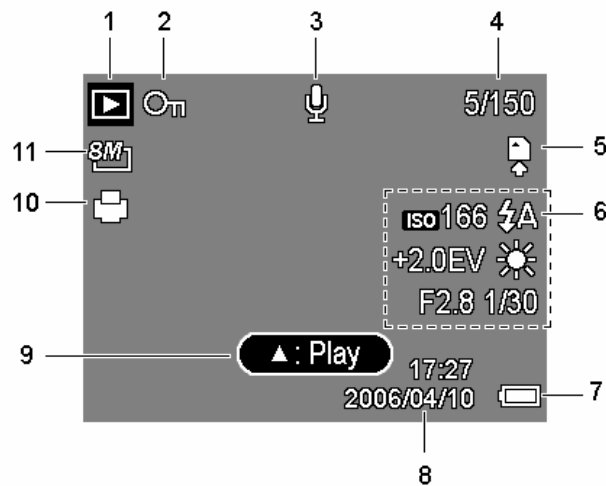

- | | | | |
|---|----------------------------|----|--------------------------------|
| 1 | Playback mode (☞ page 13) | 7 | Battery (☞ page 5) |
| 2 | Protect (☞ page 37) | 8 | Captured date & time |
| 3 | Voice memo (☞ page 28) | 9 | Voice memo control (☞ page 28) |
| 4 | File number / Total | 10 | DPOF (☞ page 42) |
| 5 | Storage media | 11 | Resolution (☞ page 21) |
| 6 | Recording info (☞ page 11) | | |

! Caution

- Some information may not display correctly if you display images captured by other camera model.

Changing the LCD Status

Press the **SET/DISP** button changes the LCD status as shown below:

■ REC mode

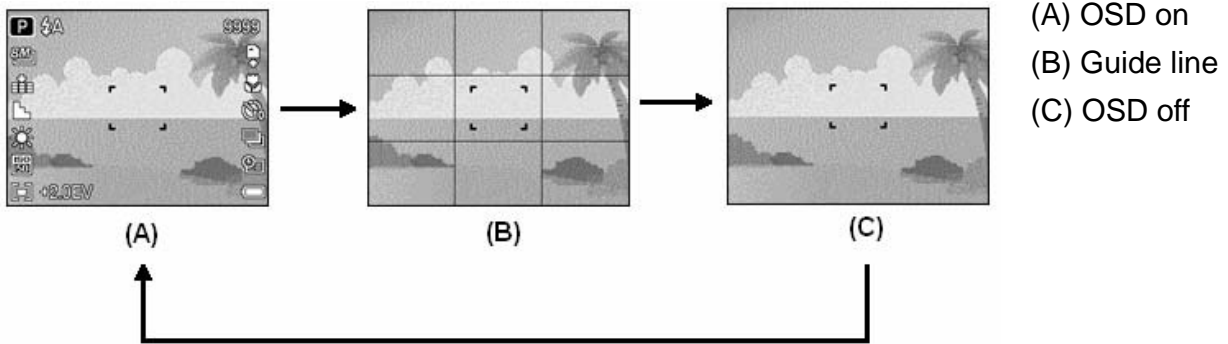

Tips

- Use the “Guide line” to compose images easily before shooting images.

■ PLAYBACK mode

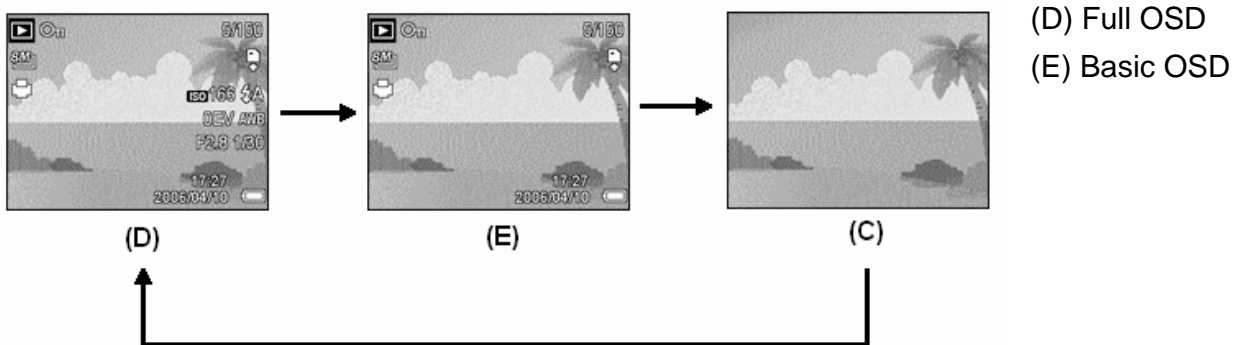

Caution

- You cannot change the LCD status in the following situation:
 - Manual exposure
 - Recording movie clips or audio files
 - Playing movie clips or audio files
 - Playing the slideshow
 - Viewing in thumbnail
 - Trimming a still image
- When the LCD status is not in “OSD on”, press Macro (◀) or Flash (▶) will change the display mode to “OSD on” automatically.

Basic Operation

Turning the Power On and Off

1 Press the **POWER** button (❶) to turn on the camera in the **REC** mode.

- The power turns on, the lens extends and the LED lights in green.

Press the **PLAYBACK** button (❷) to turn on the camera in the **PLAYBACK** mode.

- The power turns on, and an image displays on the LCD monitor (❸).

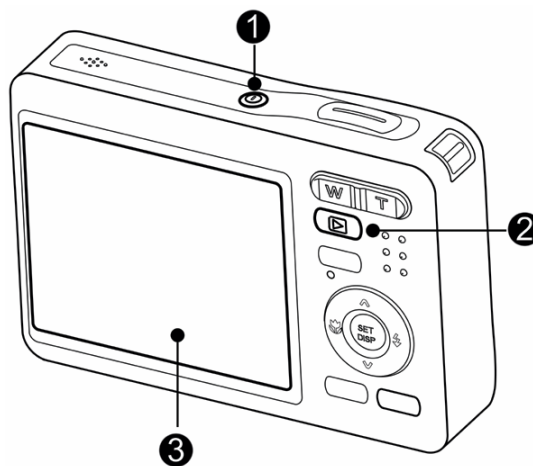

2 Press the **POWER** button (❶) again to turn the power off.

- The power turns off, the lens retracts and the LED turns off.

? Tips

- You can turn on the camera without the start-up and operating sound by pressing and holding the **POWER** (❶) or the **PLAYBACK** (❷) button over 1.5 seconds.
- Switch between **REC** mode and **PLAYBACK** mode (👉 page 13).

Power Saving Function

For saving the battery power, the LCD monitor automatically turns off 1 minute after the last control accessed (factory-preset setting). Press any button other than the power button to turn on the LCD monitor. You can change the power save setting in Setup menu (👉 page 17).

After the power saving function has been active for 1 minute, the power will turn off completely. Press the **POWER** (❶) or the **PLAYBACK** (❷) button to restore the power.

The power save feature will not activate in the following situation:

- Recording movie clips or audio files
- Playing movie clips or audio files
- Playing the slideshow
- Connecting the camera to a computer or printer with the USB cable

Changing the Mode

You can record images and voices in the REC mode. And using the PLAYBACK mode to replay, delete, or edit images on the LCD monitor.

Switching between REC mode and PLAYBACK mode

In REC mode: press the **PLAYBACK** button (❶) to switch to the PLAY mode.

In PLAY mode: press the **PLAYBACK** (❶) or the **MODE** (❷) button to switch to the REC mode.

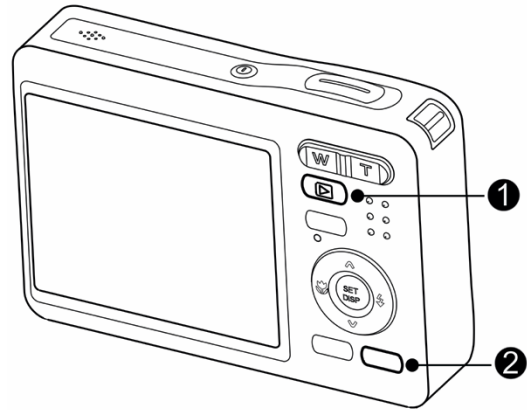

Selecting the REC mode

1 Set the camera to the REC mode (👉 page 13).





2 Launch the mode palette.



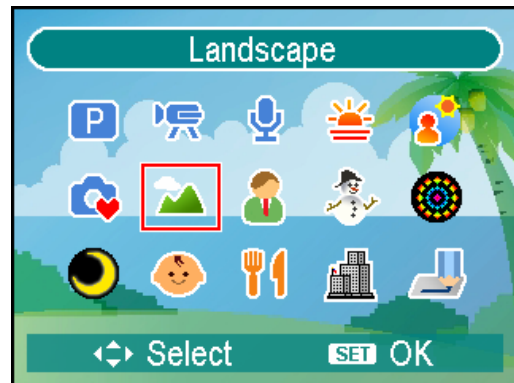







- Press the **MODE** button (❷) to show the scene mode palette.

3 Select a mode.

- Use the four-way control to select a desired mode and press the **SET** button to confirm the setting.



Display	Title	Description
	Program	The camera makes settings suitable for the shooting conditions.
	Movie	For recording movie clips.
	Voice REC	For recording audio.
	Sunset	Enhance the red tone for recording sunset images.
	Backlight	Shooting the image of backlight object by changing metering.

Display	Title	Description
	Q Mode	Allows beginners to take pictures easily.
	Landscape	Used for the wide scenic views.
	Portrait	Blurring the background to focus on the subject.
	Snow	Used for the beach or snow scenes.
	Fireworks	Slow shutter speed to take fireworks exploding.
	Night Scene	Shooting the subject while keeping the background night scenery.
	Kids	Take a still image to capture moving kids.
	Food	Higher saturation makes food more appetizing.
	Building	Enhance the edges of the subject.
	Text	Enhance the black & white contrast.

Using the Menu

When a menu is displayed, the four-way control and the **SET** button are used to make the desired settings.

REC menu

1 Turn the power on, and set the camera to the REC mode (page 13).

2 Open the REC menu.

- Press the **MENU** button (1) to display the menu.

3 Select an item.

- Press ◀ or ▶ (2) to select a menu item.

4 Change the setting.

- Press ▲ or ▼ (2) to change the setting.

5 Press the **MENU** (1) or the **SET** (2) button to save the settings and close the menu.

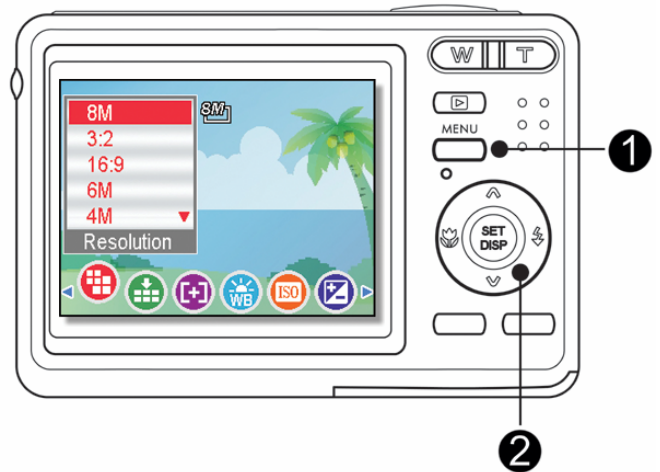

REC menu list (Still Image)

Menu Item	Available Setting	Page
Resolution	8M / 3:2 / 16:9 / 6M / 4M / 2M / VGA	21
Quality	High / Medium / Low	21
Metering	Spot / Center / Multi	29
White Balance	Auto / Daylight / Cloudy / Tungsten / Fluorescent / LED / Custom	29
ISO	Auto / ISO 50 / ISO 100 / ISO 200 / ISO 400	30
Exposure	-2.0EV ... +2.0EV	30
Drive Mode	Off / 2 / 10 / Self / Off	25
AEB	Off / On	30
Highlight	Off / Off / On / On	30
Sharpness	Low / Medium / High	31

Effect	Off / B&W / Sepia / Negative / Red / Green / Blue	31
Date Stamp	Off / Date / Date & Time	31
Digital Zoom	Off / On	22

REC menu list (Movie)

Menu Item	Available Setting	Page
Movie Size	16:9 / 640 / 320	26
Metering	[☉] / [■] / [•]	29
White Balance	Auto / [☀] / [☁] / [☀] / [H] / [L] / [⬇]	29

Setup menu

1 Turn the power on, and set the camera to the REC or PLAYBACK mode (☞ page 13).

2 Press the MENU button (①) to open the REC or PLAYBACK menu.

- The menu displays depends on whether you are in the REC mode or the PLAY-BACK mode.

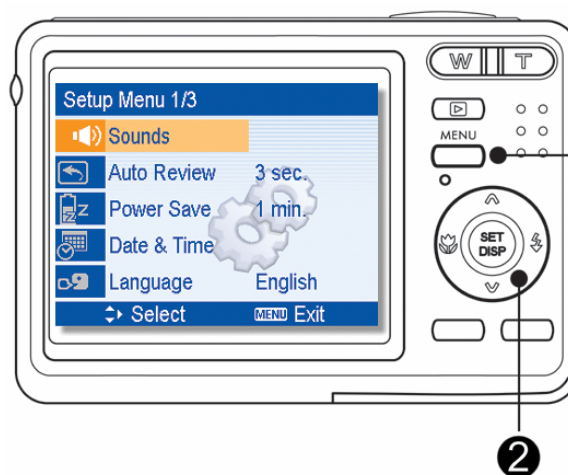

3 Open the Setup menu.

- Press four-way control (②) to select **SETUP** (⚙) and then press the **SET** (②) button to display the Setup menu.

4 Select an item.

- Press ▲ or ▼ (②) to select a menu item and then press ► or the **SET** (②) button to launch the submenu.

5 Change the setting.

- Press ▲ or ▼ (②) to select an option and press ◀ or the **SET** (②) button to apply the setting.

Setup menu list

Menu Item	Functions																						
Sounds	<p>[Shutter]: Sets the shutter sound on and off.</p> <p>[Start-up]: Sets a type of the start-up sound.</p> <p>[Beep]: Sets the operation sound on and off.</p> <p>[Volume]: Adjusts the volume of the shutter sound, start-up sound, beep and playback sound.</p>																						
Auto Review	<p>[Off]: The captured image will not automatically display after shooting.</p> <p>[3 sec.]: The captured image will display for 3 seconds after shooting.</p> <p>[5 sec.]: The captured image will display for 5 seconds after shooting.</p>																						
Power Save	<p>[1 min.] / [3 min.] / [5 min.]: For power consumption, the camera is turned off automatically for a period of time.</p> <ul style="list-style-type: none"> The power save feature will not activate in some situation (☞ page 12). 																						
Date & Time	Sets the date & time (☞ page 7).																						
Language	<p>Select a language for display menus and other information from the following 21 languages: (☞ page 7)</p> <table> <tbody> <tr> <td>[English]: English</td> <td>[繁體中文]: T. Chinese</td> </tr> <tr> <td>[Deutsch]: German</td> <td>[Español]: Spanish</td> </tr> <tr> <td>[Italiano]: Italian</td> <td>[Français]: French</td> </tr> <tr> <td>[Nederlands]: Dutch</td> <td>[Português]: Portuguese</td> </tr> <tr> <td>[Magyar]: Hungarian</td> <td>[Čestina]: Czech</td> </tr> <tr> <td>[Türk]: Turkish</td> <td>[Polski]: Polish</td> </tr> <tr> <td>[Svenska]: Swedish</td> <td>[Русский]: Russian</td> </tr> <tr> <td>[Rumänisch]: Romanian</td> <td>[Ελληνικά]: Greek</td> </tr> <tr> <td>[ايرع]: Arabic</td> <td>[日本語]: Japanese</td> </tr> <tr> <td>[ไทย]: Thai</td> <td>[简体中文]: S. Chinese</td> </tr> <tr> <td>[한국어]: Korean</td> <td></td> </tr> </tbody> </table>	[English]: English	[繁體中文]: T. Chinese	[Deutsch]: German	[Español]: Spanish	[Italiano]: Italian	[Français]: French	[Nederlands]: Dutch	[Português]: Portuguese	[Magyar]: Hungarian	[Čestina]: Czech	[Türk]: Turkish	[Polski]: Polish	[Svenska]: Swedish	[Русский]: Russian	[Rumänisch]: Romanian	[Ελληνικά]: Greek	[ايرع]: Arabic	[日本語]: Japanese	[ไทย]: Thai	[简体中文]: S. Chinese	[한국어]: Korean	
[English]: English	[繁體中文]: T. Chinese																						
[Deutsch]: German	[Español]: Spanish																						
[Italiano]: Italian	[Français]: French																						
[Nederlands]: Dutch	[Português]: Portuguese																						
[Magyar]: Hungarian	[Čestina]: Czech																						
[Türk]: Turkish	[Polski]: Polish																						
[Svenska]: Swedish	[Русский]: Russian																						
[Rumänisch]: Romanian	[Ελληνικά]: Greek																						
[ايرع]: Arabic	[日本語]: Japanese																						
[ไทย]: Thai	[简体中文]: S. Chinese																						
[한국어]: Korean																							
File No.	<p>Use this function if the camera experiences a “Folder cannot be created” error or if you want to restart numbering, for example, after erasing all files.</p> <p>[Series]: Store the latest used file number no matter deleting files or inserting a new memory card.</p>																						

Menu Item	Functions
	<p>[Reset]: Reset file numbering each time the memory card is changed.</p> <ul style="list-style-type: none"> Resetting the file number is useful for avoiding the file name duplication when images are downloaded to a computer (👉 page 46).
TV Out	<p>You can review images on a television with a supplied AV cable (👉 page 44). TV Out should be set to either NTSC or PAL depending on your region.</p> <p>[NTSC]: America, Japan and others [PAL]: Europe, Oceania and others</p>
USB	<p>[Computer] / [Printer]: Sets the USB mode to connect the camera with a printer or computer (👉 page 45).</p>
Start-up Image	<p>Sets a recorded image as the start-up image (👉 page 43).</p>
Format	<p>To erase all data stored in the memory card if you are using a card, or all data stored in the internal memory if there is no card inserted.</p> <ul style="list-style-type: none"> A “BUSY...PLEASE WAIT” message displays and the memory card is starting format. A “COMPLETED” message displays when finish formatting. All data will be deleted including protected files. Be sure to download important files to your computer before formatting.
Battery Type	<p>To ensure the camera displays battery level correctly, set the type to match the batteries used.</p> <p>[Alkaline]: When use alkaline batteries. [NiMH]: When use NiMH batteries.</p>
Reset All	<p>Resets the entire menu and button operation settings to initial default.</p> <p>The following settings do not change after Reset All:</p> <ul style="list-style-type: none"> Date & Time setting Language setting TV out setting Battery Type

Basic Recording

Recording Still Images

1 Turn the power on, and set the camera to the REC mode (page 13).

2 Compose the subject on the monitor.

- Aim the focus area (1) to the subject that you want to take.

3 Half press the shutter button to focus the image.

- The focus area (1) becomes green while in focus, then shutter speed (2), aperture value (3) and ISO value (4) are displayed.
- If the shutter speed is slow or the possibility that image may be blurred, the shake warning icon !👉 may appear on the LCD monitor. To avoid this, use a tripod to stabilize the camera when recording images.

4 Take a picture.

- Press the shutter button fully to take a picture.

! Caution

- Make sure that your fingers or the wrist strap does not block the lens.

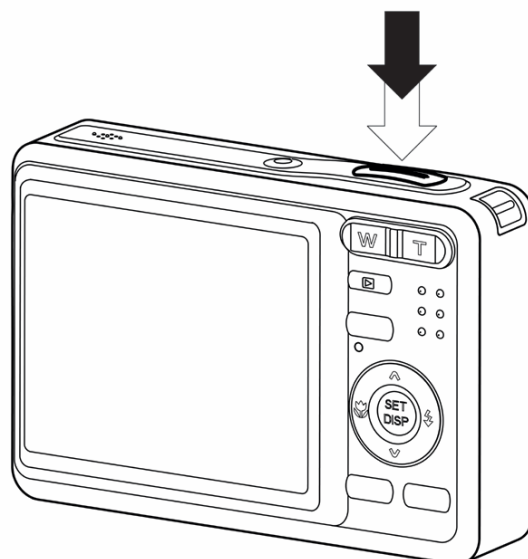
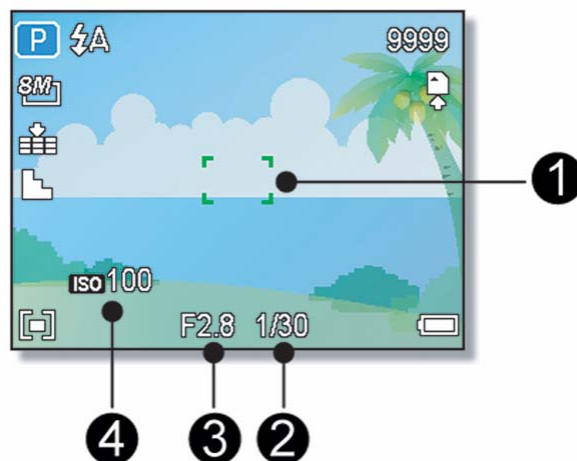

Using the Q mode

The Q mode provides a simplified camera interface. Larger icons and fewer controls make it easier to take pictures anytime, especially for the beginners and elder users.

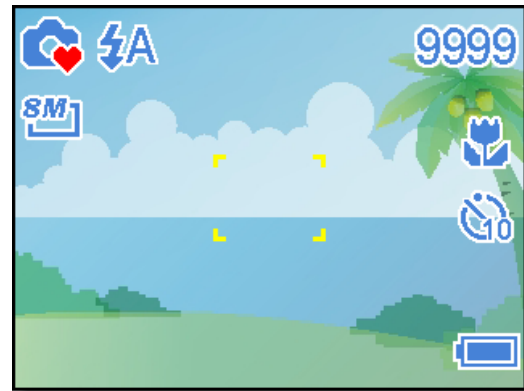

You can use only the basic settings in the Q mode:

Button	Flash: Auto / Red eye / Force on / Slow sync / Force off
	Macro: Off / On
	SET/DISP: OSD on / Guide line / OSD off
Menu	Resolution: 8M / 3:2 / 16:9 / 6M / 4M / 2M / VGA
	Drive Mode: Off / 2 sec. / 10 sec. / Double / Burst
	Beep: Off / On
	Auto Review: Off / 3 sec. / 5 sec.

Rest of settings will not be controlled as below:

Fixed setting (*)	<ul style="list-style-type: none"> • Quality: S.Fine • Metering: Multi • White balance: Auto • ISO: Auto • Exposure: Auto • AEB: Off • Highlight: Off • Sharpness: Normal • Effect: Off • Date Stamp: Date & Time • Digital Zoom: Off
Utility setting (**)	<ul style="list-style-type: none"> • Shutter sound • Start-up sound • Power save • Date & Time • Language • File No. • TV out • USB • Start-up image







(*)Fixed setting: Settings are fixed in Q mode.

(**)Utility setting: Use the same setting as last mode used.



Setting Image Size and Quality

You can select lower image resolution and quality to decrease the image size to capture more images. Choose a suitable setting according to the desired image quality and purpose. For details, see page 15.

Resolution Values

Image Size		Print Size	
	3264 x 2448	Printing larger than A4-size.	Larger ↑ ↓ Smaller
	3264 x 2176		
	3264 x 1840		
	2816 x 2112		
	2272 x 1704		
	1600 x 1200	Printing to postcards or attaching to e-mail.	
	640 x 480		

Quality Values

Compression		Purpose	
	Super Fine	Shoot higher quality images.	Higher Quality ↑ ↓ Lower Quality
	Fine	Shoot normal quality images.	
	Normal	Shoot for more images.	

Using the Zoom Function

Your camera has a combination of optical and digital zoom functions that allows you to zoom in on far away subjects or zoom out for a wide angle shot.

The optical zoom is achieved by mechanically adjusting the lens of the camera. The digital zoom enlarges or shrinks the image using a software process.

1 Select the zoom setting, and point the camera at the subject.

2 Press the zoom button (1) to compose the image.

[W]: zoom out for a wide-angle shot.

[T]: zoom in for a telephoto shot.

- When the zoom button is pressed, the zoom bar appears on the LCD monitor.
- When the optical zoom (2) factor is at maximum, zooming stops temporarily. Press the [T] again, the camera switches to the digital zoom (3) automatically and zooming continues.
- The digital zoom (3) will not activate in movie recording.

3 Press shutter button to take a picture.

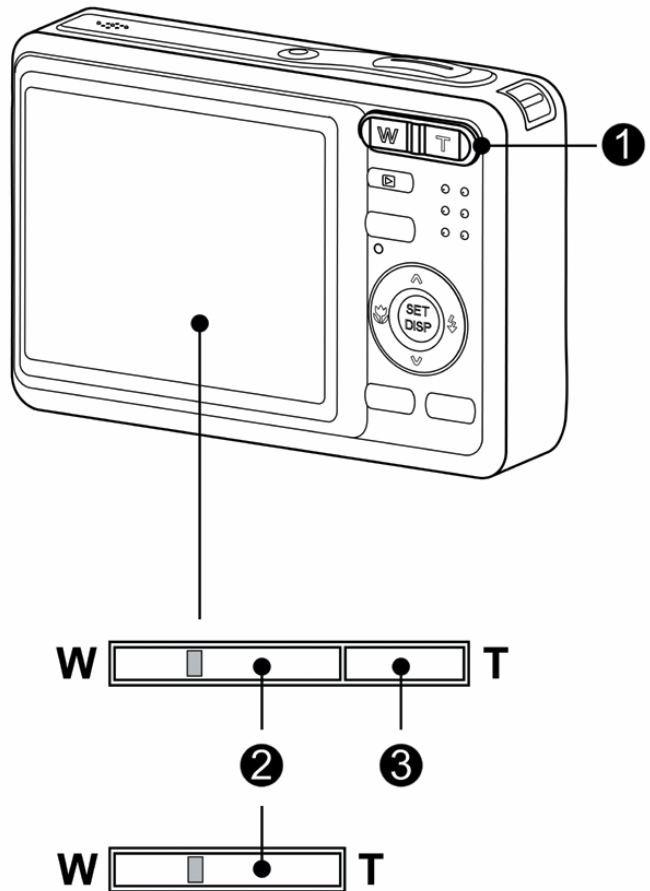

? Tips

- Digital zoom works by enlarging the center portion of an image through a software interpolation process.
- The digital zoom is used to achieve magnification levels up to approx. 4 times.

Using the Flash

The flash is not only for taking pictures when there is insufficient light, but also when the subject is in shade or in backlight conditions. Press the flash button to cycle your camera through the various flash modes. The flash will not activate when continuous shooting or movie recording.

1 Turn the power on, and set the camera to the REC mode (☞ page 13).

2 Press the flash button (●) to change the flash mode.

- Each time the flash button is pressed, the flash icon (●) changes.

⚡ Auto flash:

The flash flashes automatically when shooting conditions require extra lighting.

⚡ Red-eye reduction:

Flash strobos to let the subject's eyes adjust to the flash, then flash again to take the actual image. Your camera will detect the subject brightness and use the flash only when required.

⚡ Force on:

The Flash flashes every time you take a photo, regardless of lighting conditions.

S⚡ Slow sync:

The Flash flashes with a slow shutter speed.

⚡ Force off:

The flash does not work in dark situation.

3 Press shutter button to take a picture.

! Caution

- The flash charging time may increase when the battery is low.
- The available flash settings are limited depending on the REC mode you selected (☞ page 49).

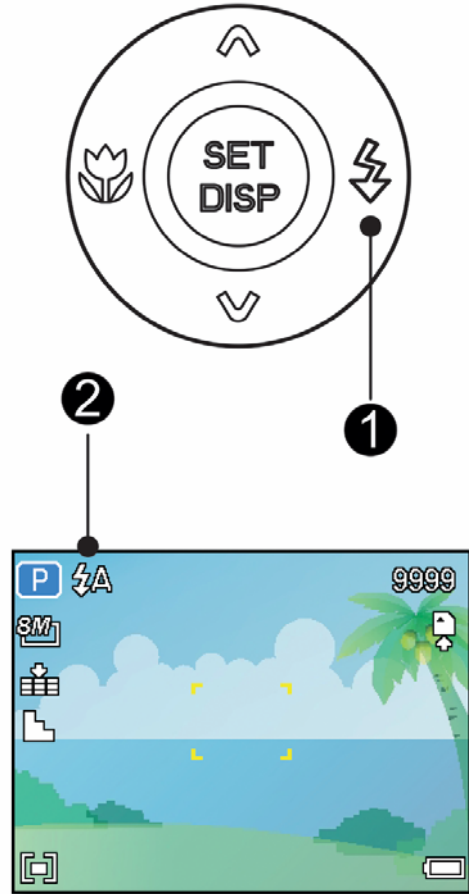

Using the Macro

Your camera is equipped with a macro function that allows you to focus on very close subjects. In macro mode you can focus on subjects 15 cm from the lens when in the maximum wide angle setting and 40 cm in the maximum telephoto setting.

1
Turn the power on, and set the camera to the REC mode (☞ page 13).

2
Press the macro button (①) to enter the macro mode.

- The macro icon (②) displays in the LCD monitor.
- To leave the macro mode, press the macro button (①) again.

3
Press shutter button to take a picture.

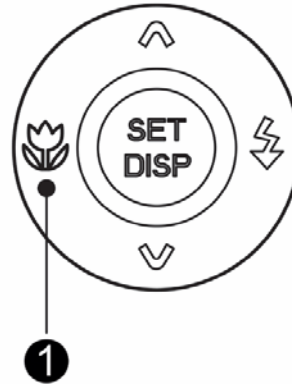

? Tips

- Distances referred to measure the distance between the camera lens surface and the subject.

Using the Self-timer & Burst

Use the self-timer to set a delay from the time the shutter button is pressed to the time the image is shot. Use the burst to record continuous still images shooting.

1
Turn the power on, and set the camera to the REC mode (☞ page 13).

2
Open the REC menu (☞ page 15).
• Use ◀ or ▶ to select [Drive mode] from the REC menu.

3
Change the setting.
• Press ▲ or ▼ to select a drive mode, then press the **SET** button.

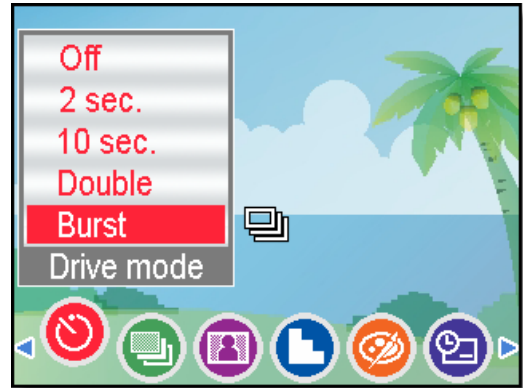

Off:

Record a single image.



2 sec.:

The shutter release will be delay for 2 seconds.



10 sec.:

The shutter release will be delay for 10 seconds.



Double:

Record two images in a shot after pressing the shutter release button 10 and 12 seconds.



Burst:

Keep pressing the shutter button fully to take continuous shooting. Release the shutter button to stop shooting.

4
Press shutter button to take a picture.



Tips

- When using the self-timer function, be sure to use a tripod or place the digital camera on a level, stable surface.

Recording Movie Clips

1 Turn the power on, and set the camera to the Movie mode (☞ page 13).

2 Compose the subject on the monitor.

- Aim the focus area (④) to the subject that you want to take.
- The LCD monitor displays the available recording time (ⓐ).

3 Start recording.

- Press the shutter button (①) to start recording.
- Using the zoom button (②) to adjust the image size.
- The White Balance is set and locked to the settings of the first frame

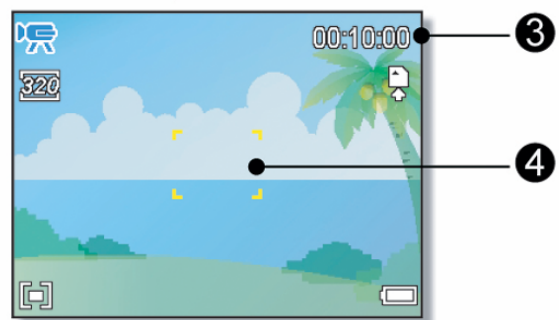
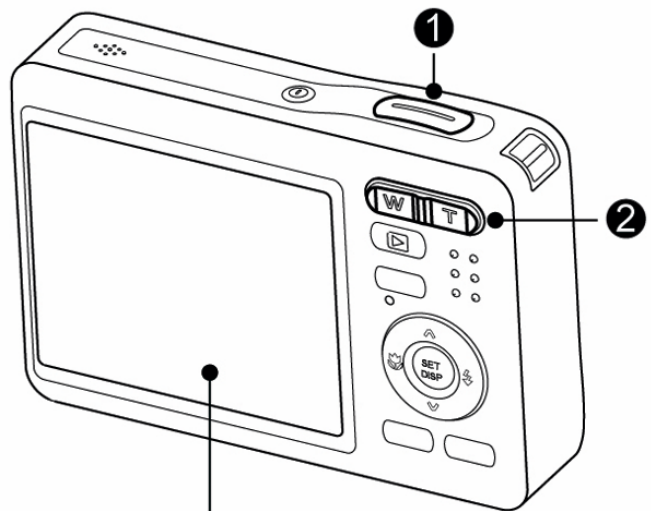

! Caution

- Sound cannot be recorded while pressing the zoom button..
- The digital zoom cannot be used in Movie mode.

4 Finish recording.

- Press the shutter again to end recording.
- The camera will stop recording automatically when the memory capacity has been reached.

Setting the Movie Size

Movie Size and Frame Rate

Resolution		Frame Rate	
<u>16:9</u>	720 x 400	30 frames/sec.	Higher Quality ↕ Lower Quality
<u>640</u>	640 x 480		
<u>320</u>	320 x 240		

Recording Audio Clips

1 Turn the power on, and set the camera to the Voice REC mode (☞ page 13).

2 Press the shutter button (❶) to start recording.

- The voices are recorded from the microphone (❷) of the camera. Be careful to avoid touching the microphone while recording.

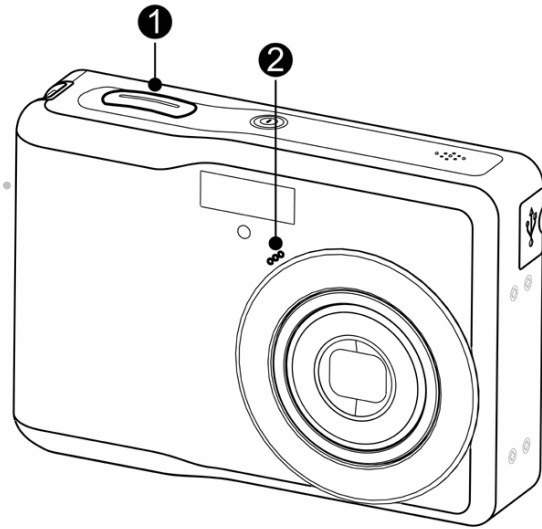

3 Press the shutter button again to end recording.

- The camera will stop recording automatically when the memory capacity has been reached.

Playing Back Audio Clips

1 Turn the power on, and set the camera to the PLAYBACK mode (☞ page 13).

2 Press ◀ or ▶ to select the audio clip that you want to playback.

3 Start playing back.

- Press ▲ to start playing the audio clip.
- Press ▼ to stop the audio clip, or press ▲ to pause it. When audio clip paused, press ▲ again to resume.

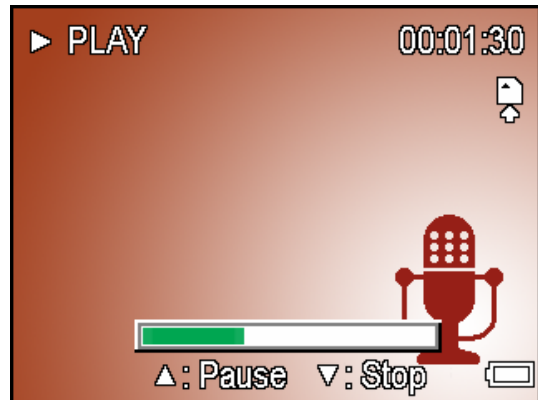

Recording a Voice Memo

You can add a voice memo to the still images after you record it.

1 Turn the power on, and set the camera to the **PLAYBACK** mode (☞ page 13).

2 Press ◀ or ▶ to select a still image that you want to add a voice memo.

- If the image already has the voice memo recorded, the  appears on the LCD monitor. The new recording will replace the previous one.

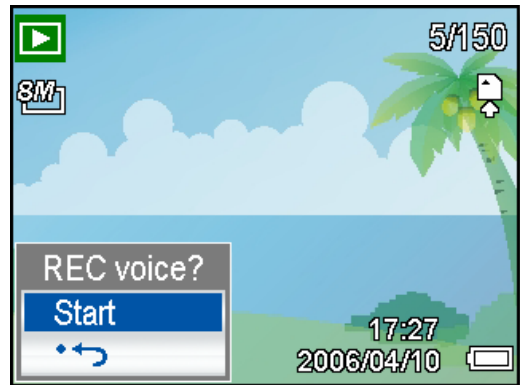

3 Open the **PLAYBACK** menu.

- Press the **MENU** button, using four-way control to select **Voice Memo** () and press the **SET** button.

4 Press the **SET** button to start recording for 30 seconds.

- Press the **SET** button again to end recording.

! Caution

- The voice memo cannot be added to a movie clip or a protected image.
- You cannot delete only the voice memo. When you delete the image, the attached voice memo is also deleted.

Playing Back a Voice Memo

1 Turn the power on, and set the camera to the **PLAY** mode (☞ page 13).

2 Press ◀ or ▶ to select the image that has the voice memo recorded.



3 Start playing back.

- Press ▲ to start playing the voice memo.
- Press ▼ to stop the voice memo, or press ▲ to pause it. When voice memo paused, press ▲ again to resume.

Other Recording Functions







Setting the Metering

There are 3 different light metering options available on your camera.

Option	Description
	Light is measured from the entire shooting screen, but gives more importance to the values near the center.
	Selects an exposure based on readings from multiple points in the subject area.
	Selects an exposure based on a single reading taken from the center of your picture.

Setting the White Balance

Adjust the white balance to match different light sources such as sunlight, incandescent (tungsten) lighting or, fluorescent lighting.

Option	Description
AUTO	Automatically corrects white balance. Ideal for general photography.
	Adjusts for bright sun conditions, or natural light conditions.
	Adjusts for cloudy days or twilight conditions.
	Adjusts for normal indoor lighting conditions. Corrects the orange hue of household light bulbs. Ideal for indoor photos under tungsten or halogen lighting without a flash.
	Adjusts for fluorescent lighting. Corrects the green hue of fluorescent lighting. Ideal for indoor photos under fluorescent lighting without a flash.
	
	For more accurate adjustment or when the light source cannot be specified.



Tips

- Point the camera at a white piece of paper or similar object under the lighting conditions for which you want to set the white balance, and then press the Shutter button.

Setting the ISO

With the initial settings, the ISO sensitivity is automatically set according to the brightness of the subject.

Option	Description
Auto	Sets the ISO sensitivity automatically.
ISO 50	Sets the sensitivity to ISO 50 equivalent.
ISO 100	Sets the sensitivity to ISO 100 equivalent.
ISO 200	Sets the sensitivity to ISO 200 equivalent.
ISO 400	Sets the sensitivity to ISO 400 equivalent.



Tips

- Higher ISO speeds increase the image noise. To take clean images, use as low an ISO speed as possible.



Setting the Exposure

Set the exposure value manually to compensate for unusual lighting conditions such as indirect indoor lighting, dark backgrounds, and strong backlighting.

Setting the AEB



Sets the auto exposure bracketing (AEB) to shoot 3 continuous images, each with a different exposure setting: correctly exposed, underexposed, and overexposed.

Setting the Highlight

Make the subject stand out from its surroundings. The subject will be in focus in three different ranges:  /  / 

Setting the Sharpness

You can select whether you want the image to have sharp or soft outlines.

Option	Description
	The edges of the image are emphasized. The edges will become sharp, but noise may occur in the recording image.
	The edges of the image are sharp. This is suitable for printing.
	The edges of the image are softened. This is suitable for editing images on PC.

Setting the Photo Effect

You can add special effects to your images in Record mode or in Playback mode.

Option	Description
Off	No effect is added to the image.
B&W	Convert image to black & white.
Sepia	Recorded image will be stored in a sepia tone.
Negative	Opposite what they were in the original image.
Mosaic	Add mosaic tiles to the images. (Playback only)
Red	The image becomes reddish.
Green	The image becomes greenish.
Blue	The image becomes bluish.

Setting Date Stamp

The Date Stamp function can be used to add a date to your pictures as you take them.

Option	Description
Off	Do not add the recorded date & time to printed images.
Date	Only add the recorded date to printed images.
Date & Time	Add the recorded date & time to printed images.

Playback

Playback Images

1 Turn the power on, and set the camera to the **PLAYBACK** mode (☞ page 13).

- The latest recorded image appears on the LCD monitor.
- If there are no images stored, a message **[No image]** appears.

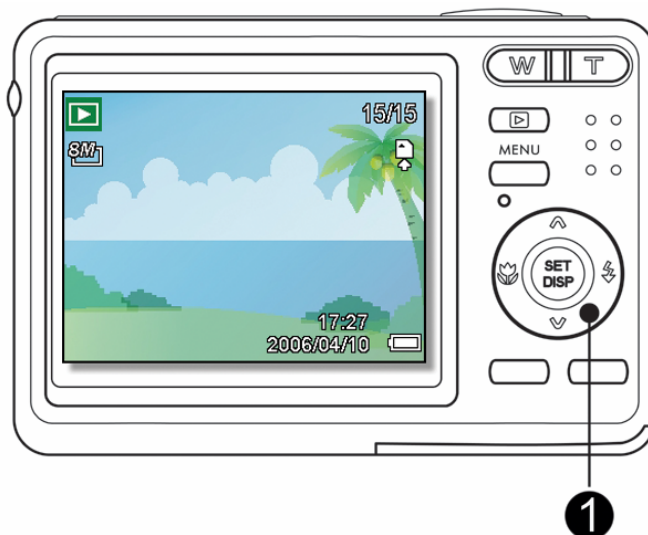

2 Press the four-way control ◀ or ▶ (①).

- ◀: displays the previous image.
- ▶: displays the next image.

? Tips

- Holding down ◀ or ▶ scrolls images in a high speed.

Playing Back Movie Clips

1 Turn the power on, and set the camera to the **PLAYBACK** mode (☞ page 13).

2 Press ◀ or ▶ to select a movie clip that you want to playback.

3 Start playing back.

- Press ▲ to start playing the movie clip.
- Press ▼ to stop the movie clip, or press ▲ to pause it. When the movie paused, press ▲ again to resume.

? Tips

- During movie playing back, press ▶ to fast forward or press ◀ to rewind it.
- Press the shutter to capture the still image from the movie clip while it had paused.

1

Turn the power on, and set the camera to the **PLAYBACK** mode (👉 page 13).

2

Select an image.

- Press ◀ or ▶ (⏪) to select the image that you want to magnify or trimming.
- Only still images can be magnified and trimmed.

3

Magnify the image.

- Press [T] (1) to magnify the image, and the central portion of the image is displayed. You can use the arrow button (⏪) to view different parts of the magnified image.
- Press the **MENU** button (2) to return to the normal size.

4

Trim the image.

- Press the **SET** button (3) to set the image trimming.

5

Save the image.

- Press the **SET** button (3) again to trim the selected image and save it as a new one.

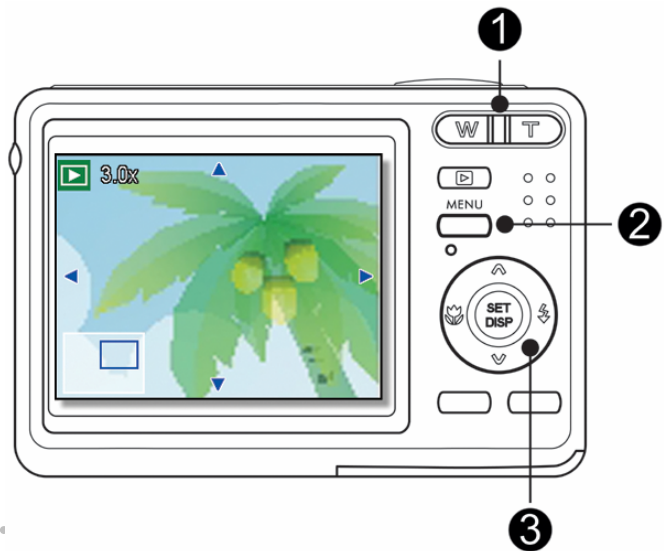

Viewing in Thumbnail

1 Turn the power on, and set the camera to the **PLAYBACK** mode (page 13).

2 Press the zoom button [W], a thumbnail screen is displayed.

3 Use the four-way control to select the desired image, and press [T] or the **SET** button to show the selected image in full screen.



? Tips

- You can protect or delete multiple images in thumbnail, see page 36, 38.

Playing a Slide Show

1 Turn the power on, and set the camera to the **PLAYBACK** mode (page 13).

2 Enter the slide show.

- Press the **MENU** button (1), use the four-way control (2) to select **Slide Show** (📺) and press the **SET** button (2).

3 Change the slide show settings.

- Use the four-way control (2) to set the slideshow interval (🕒), effect (📷) and repeat (🔄).
- You can set the interval between 1~10 seconds.

4 Playing the slide show.

- Press the **SET** button (2) to start the slideshow.
- During the slideshow, press the **SET** button (2) to pause the slideshow and press the **SET** button again to resume.

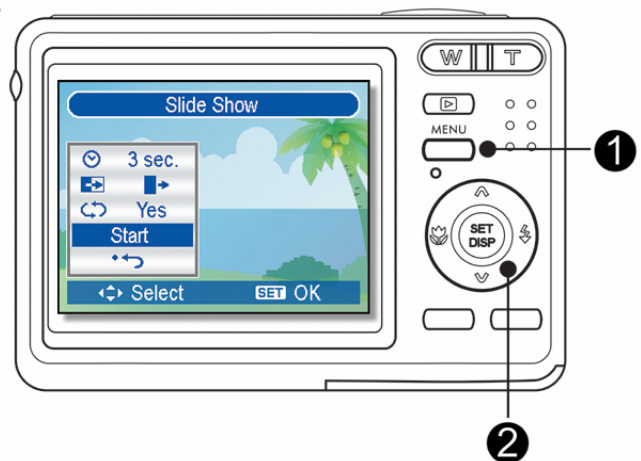

Deleting Files

Deleting a Single File

1 Turn the power on, and set the camera to the **PLAYBACK** mode (👉 page 13).

2 Open the menu.

- Press the **MENU** button (❶), then use the four-way control (❷) to select **Delete** (🗑️) and press the **SET** button (❸).

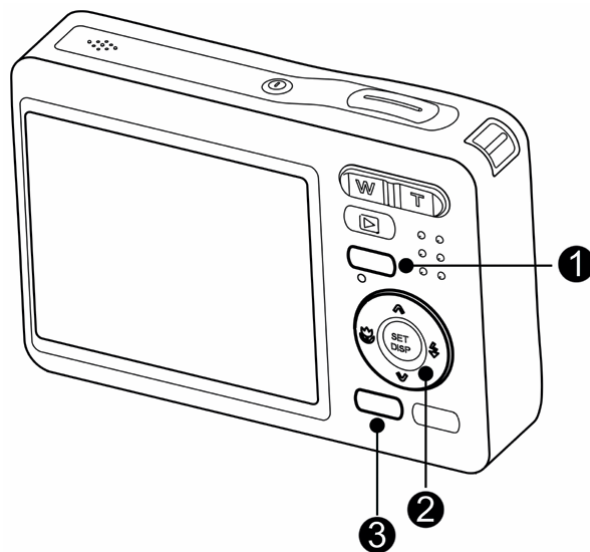

3 Press ▲ or ▼ (❷) to select **[SINGLE]**, and then press the **SET** button (❸).

4 Press ◀ or ▶ (❷) to select the image you want to delete.

5 Press the **SET** button (❸) to delete the image.

- Repeat step 4~5 to delete images.

? Tips

- To quickly delete the current display image
 1. Select the image you want to delete.
 2. Press the **Delete** button (❸) to show a confirmation.
 3. Press the **SET** button (❷) to delete the current display image.
- Protected images cannot be deleted with this function.

Deleting Multiple Files

1 Turn the power on, and set the camera to the thumbnail screen (☞ page 34).

2 Open the menu.

- Press the **MENU** button, then Press ◀ or ▶ to select to select **Delete** (🗑️) and press the **SET** button.



3 Press ▲ or ▼ to select [Select], and then press the **SET** button.

- The frame of the selected image turns green.

4 Select multiple images.

- Use the four-way control to select the image.
- Press the **SET** button toggles the 🗑️ on and off. Repeat this step until all images that you want to delete are displayed with an 🗑️.

5 Delete images.

- Press the **MENU** button, then select [Yes] and press the **SET** button. All selected images will be deleted.
- To cancel delete, press the **MENU** button in this step.

Deleting All Files

1 Turn the power on, and set the camera to the **PLAYBACK** mode (☞ page 13).

2 Open the menu.

- Press the **MENU** button, then use the four-way control to select **Delete** (🗑️) and press the **SET** button.
- You can open the menu in full screen or in thumbnail.

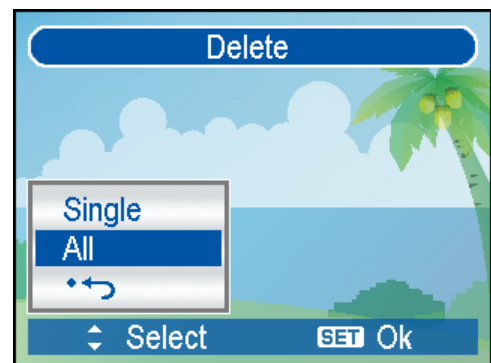

3 Press ▲ or ▼ to select [ALL], and then press the **SET** button.

4 Press the **SET** button to delete all unprotected images.

Protecting a Single File

1

Turn the power on, and set the camera to the **PLAYBACK** mode (☞ page 13).

2

Open the menu.

- Press the **MENU** button, then use the four-way control to select **Protect** (⊙Π) and press the **SET** button.

3

Press ▲ or ▼ to select **[SINGLE]**, and then press the **SET** button.

4

Press ◀ or ▶ to select the image you want to protect.

5

Press the **SET** button to protect the image.

- When the file is locked, the ⊙Π displays on the LCD monitor.
- Repeat step 4~5 to protect images.
- To unlock the file, press the **SET** button again in step 5. The ⊙Π will disappear and the file is unlocked.

Protecting All Files

1

Turn the power on, and set the camera to the **PLAYBACK** mode (☞ page 13).

2

Open the menu.

- Press the **MENU** button, then use the four-way control to select **Protect** (⊙Π) and press the **SET** button.
- You can open the menu in full screen or in thumbnail.

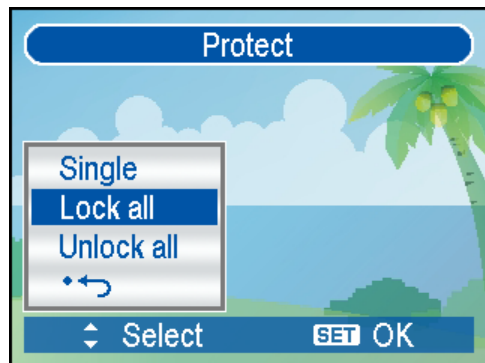

3

Press ▲ or ▼ to select **[Lock all]**, and then press the **SET** button.

- To unlock all files, select **[Unlock all]** in this step, then press the **SET** button.

4

Press the **SET** button to protect all images.

Protecting Multiple Files

1 Turn the power on, and set the camera to the thumbnail screen (page 34).

2 Open the menu.

- Press the **MENU** button, then Press ◀ or ▶ to select to select **Protect** (ⓘ) and press the **SET** button.



3 Press ▲ or ▼ to select [Select], and then press the **SET** button.

- The frame of the selected image turns green.

4 Select multiple images.

- Use the four-way control to select the image.
- Press the **SET** button toggles the ⓘ on and off. Repeat this step until all images that you want to protect are displayed with an ⓘ.

5 Protect images.

- Press the **MENU** button, then select [**Yes**] and press the **SET** button. All selected images will be protected.
- To cancel protect, press the **MENU** button in this step.

Editing Images

Rotating Still Images

1 Turn the power on, and set the camera to the **PLAYBACK** mode (👉 page 13).

2 Press ◀ or ▶ to select the image you want to rotate.

3 Open the menu.

- Press the **MENU** button, then use the four-way control to select **Rotate** (🔄) and press the **SET** button.

4 Press the **SET** button to rotate the image.

- Each press rotates the image 90 degrees in clockwise.

5 Press ▲ or ▼ to select **OK**, and then press the **SET** button to finish rotating.

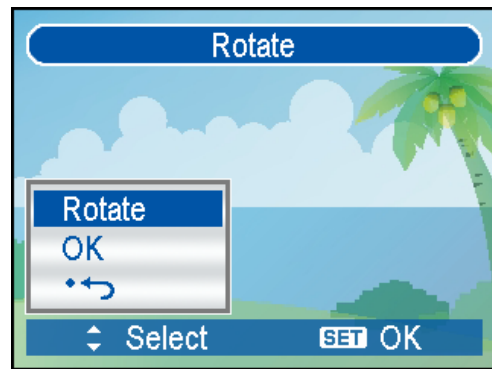

Changing the Image Size

1 Turn the power on, and set the camera to the **PLAYBACK** mode (👉 page 13).

2 Press ◀ or ▶ to select the image you want to resize.

3 Open the menu.

- Press the **MENU** button, then use the four-way control to select **Resize** (📏) and press the **SET** button.

4 Press ▲ or ▼ to select an option, and then press the **SET** button.

- The resized image will be saved as a new file.

! Caution

- Only a large size image can be resize to a smaller one.

Changing the Image with Effects

1

Turn the power on, and set the camera to the **PLAYBACK** mode
( page 13).

2

Press ◀ or ▶ to select the image you want to add the effect.

3

Open the menu.

- Press the **MENU** button, then use the four-way control to select **Effect**
() and press the **SET** button.

4

Press ▲ or ▼ to select an option, and then press the **SET** button.

- The edited image will be saved as a new file.

Copying the Files

You may copy the data from the camera's internal memory to the memory card for convenience.

1

Be sure you have inserted a memory card into your digital camera. Set the camera to the **PLAYBACK** mode. (☞ page 13).

2

Open the menu.

- Press the **MENU** button, then use the four-way control to select **Copy to card** (🔧) and press the **SET** button.

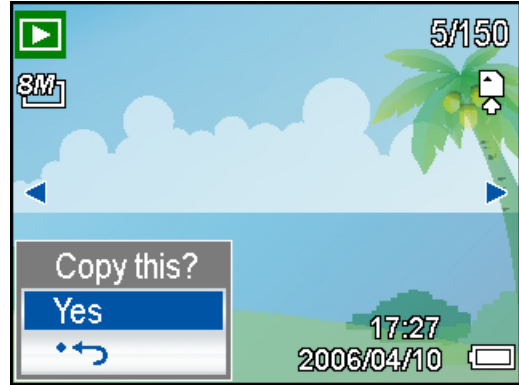

3

Press ▲ or ▼ to select **[Single]**, then press the **SET** button.

- To copy all images to a memory card, select **[All]**.

4

Press ◀ or ▶ to select the image you want to copy to a card.

5

Select **[Yes]** and then press the **SET** button to start copy.

- Repeat step 4~5 to copy other images.
- Press the **MENU** button to complete the setting.

Setting the DPOF

The Digital Print Order Format (DPOF) setting allows you to select images on the memory card for printing and specify the number of print copies in advance using the camera. This is extremely convenient for sending the images to a photo developing service or for printing on a direct print function compatible printer.

1 Turn the power on, and set the camera to the **PLAYBACK** mode (☞ page 13).

2 Open the menu.

- Press the **MENU** button, then use the four-way control to select **DPOF** (☞) and press the **SET** button.

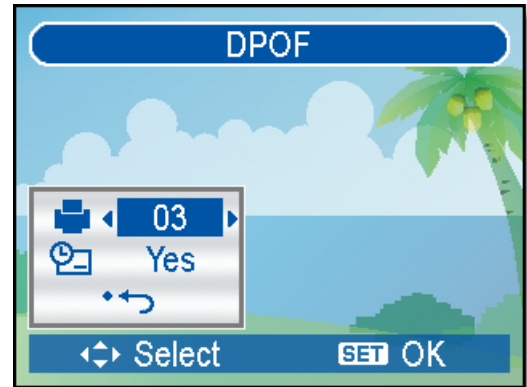

3 Press ▲ or ▼ to select **[Single]**, then press the **SET** button.

- To set the DPOF setting for all images, select **[All]** in this step.
- To reset all DPOF settings to initial default, select **[Reset]** in this step.

4 Press ◀ or ▶ to select the image you want to print out, then press the **SET** button.

5 Set the number of copies.

- Press ◀ or ▶ to specify the number of copies.
- The number of copies can be set from 0 to 30.
- To cancel this image DPOF setting, set the number of copies to 0.

6 Print the date stamp out.

- Press ▼ and then press ◀ or ▶ to set or cancel the date stamp of current image.
- Repeat step 4~6 to other images for printing.

7 Press ▼ and then press the **SET** button to apply the setting or press the **MENU** button to cancel.

8 After you finished all image settings, select [◀↶] and press the **SET** button to apply it.

Choosing a Startup Image

- 1

Turn the power on, and set the camera to the **PLAYBACK** mode (👉 page 13).
- 2

Open the menu.

 - Press the **MENU** button, then use the four-way control to select **Start-up Image** (📷) and press the **SET** button.
- 3

Press ◀ or ▶ to select the image you want, then press the **SET** button to apply the choice.

 - A message “Completed” appears.
- 4

Set the camera to the **Setup Menu** (👉 page 16).
- 5

Press ▲ or ▼ to select **Start-up** (📷) then press ▶ or the **SET** button.
- 6

Press ▲ or ▼ to select a desired option and press the **SET** button to apply the setting.

[Off]: Disable the start-up image.
[System]: Use camera default image.
[My image]: Use the image that you just specified in step 3.
- 7

Press the **MENU** button to close the menu.

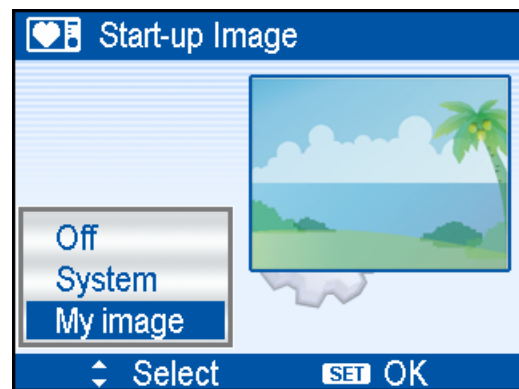

! Caution

- The start-up image will not be deleted even if the original image is deleted or memory formatted.

Making Connections

Connecting the Camera to a TV

You can display recorded images on a television with a supplied AV cable.

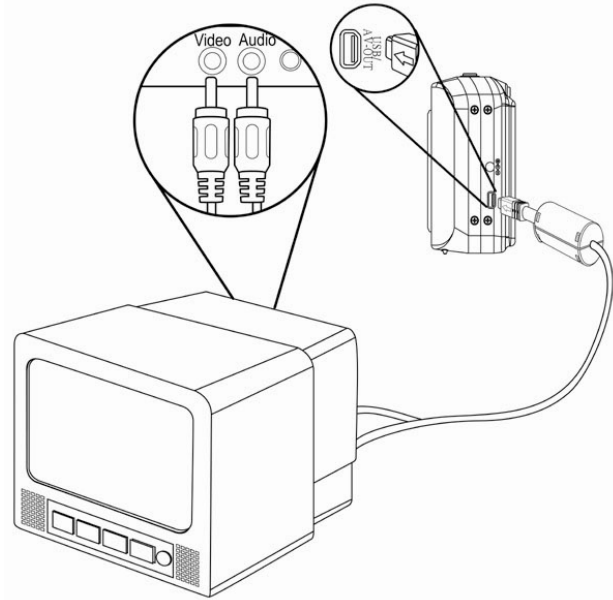

- 1
Set the TV out to match the TV system that you are using (👉 page 18).
- 2
Turn off the camera and the TV.
- 3
Use the supplied AV cable to connect the camera to the TV set.
- 4
Set the TV input signal to Video In.
 - Refer to the documentation included with your TV for more information.
- 5
Display on TV.
 - Everything that would normally appear on the camera's LCD screen, such as photo and video clip playback, slide shows, and image or video capture, appears on the TV.

Connecting the Camera to a PC

There are two ways to download files from the camera's internal memory or memory card to a computer:

- Inserting the memory card into a card reader
- Connecting the camera to a computer using the supplied USB cable

Using the Card Reader

1 Eject the memory card from the camera and insert it in a card reader that is connected to a computer.

2 Open [My Computer] or [Windows Explorer] and double-click the removable drive icon that represents the memory card.

3 Copy images from the card into a directory of your choice on the computer's hard disk.

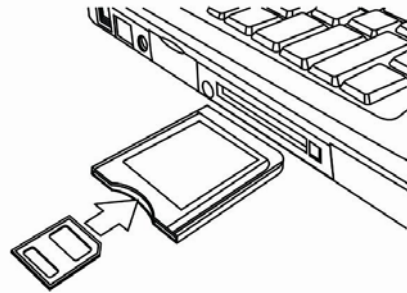

Connecting the Camera to a Computer with the USB Cable

1 Install the USB software driver included with the bundled CD-ROM.

2 Connect the supplied USB cable to the computer's USB port and turn on the camera.

- The LCD screen turns off when the connection to the computer has been successfully completed.

3 Open [My Computer] or [Windows Explorer]. A "Removable Disk" appears in the drive list.

4 Double-click the "Removable Disk" icon to view its contents.

- Files stored on camera are located in the folder name "DCIM".

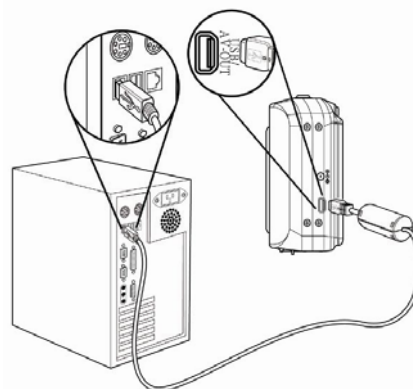

Appendix

About the Folder & File Name

Your digital camera automatically creates a directory of folders in the internal memory or memory card that it uses to organize still images, movie clips and other information.

Folder Structure

Folder name begins with a 3-digit number from 100 to 999 and followed by “DICAM”, each folder holds up to 9999 files. If new files are made, a new folder named in sequence will be made automatically.

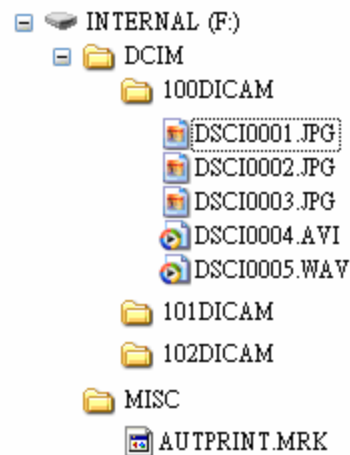

File Naming

File name begins with “DSCI” and are followed by a 4-digit number that increases in sequence. File numbering starts from 0001 when a new folder is created.

If the highest folder number is 999 and highest file number exceeds 9999, the camera will display the warning message “Folder cannot be created”. When it appears, try one of the following ways:

- Reset the file number and plug in a new memory card.
- The folder number and file number are initialized and renumbered from 100 and 0001 respectively.

Caution

- Do not change the folder and file names in the memory card using your computer. It may be unable to playback the data using the digital camera.

Troubleshooting

Problem	Cause	Solution
Power does not turn on.	Battery is inserted in the wrong direction.	Reload battery in the correct direction.
	Batteries are dead.	Replace or recharge batteries.
	The battery compartment door is open.	Make sure the battery compartment door is securely closed.
The camera does not take pictures.	The flash is charging.	Wait for the flash to charge.
	Memory is full.	Insert a new memory card.
	Memory card is not formatted correctly.	The card may be defective, use a new card.
Image is not recorded when the shutter button is pressed.	The Flash is charge.	Wait for the flash to charge.
	Memory is full.	Insert a new memory card.
The flash does not fire.	Flash is set to OFF.	Set the flash to any mode except off.
Image is blurry or out of focus.	The camera was moving when the image was captured.	Hold the camera steady when shooting picture.
	The subject was beyond the range within which the camera can focus.	Turn the Macro mode on if the subject is within 15 cm or 40 cm. Do not use Macro mode when shooting distant subjects.
Image is not displayed on the LCD monitor.	A memory card with non-DCIF images (recorded with other camera) is loaded.	This camera cannot display non-DCIF images.
Recorded images are not saved in memory.	The camera was turned off / powered down before the image was stored in memory.	If the battery low indicator appears on the LCD monitor, replace the battery immediately.
Cannot transfer images to a computer after connecting the USB cable.	USB driver is not installed.	Install the USB driver before you connect the camera to a computer / turn the camera on.
Card error	The memory card format may not be correct.	Re-format the memory card to the FAT format using a card reader in Windows.

Specifications

Sensor	8.0 MegaPixel CCD, Size : 1/2.5 inch
Lens	Focal length : f = 6.2 (W) ~ 18.6 (T) mm, 3X optical zoom, 4X digital zoom
Display	2.5" TFT LCD monitor
Focus range	Normal: 80cm ~ Infinity (from the tip of barrier) Macro: (W) 15 cm ~ 1 m / (T) 40 cm~ 1 m (from the tip of barrier)
Aperture	F/ 2.8 (W), 5.2 (T)
Shutter	8 ~ 1/2000 sec.
File format	Still Image: EXIF 2.2 compatible format (JPEG compression), DCF compatible, support DPOF, PictBridge supported, Video: AVI , Audio: WAV
Resolution	Still Image: 3264 x 2448 (8M) / 3264 x 2176 (3:2) / 3264 x 1840 (16:9) / 2816 x 2112 (6M) / 2272 x 1704 (4M) / 1600 x 1200 (2M) / 640x480 (VGA) , Video: 720x400 / 640x480 / 320x240
Scene mode	Program /Movie / Voice REC / Sunset / Backlight / Q. Mode / Landscape / Portrait / Snow / Fireworks / Night scene / Kids / Food / Building / Text
Sensitivity	Auto / ISO 50 / ISO 100 / ISO 200 / ISO 400
White balance	Auto / Daylight / Cloudy / Tungsten / Fluorescent (H) / Fluorescent (L) / Custom
Exposure control	-2EV to +2EV in 1/3 step
Metering	Center-weighted / Multi / Spot
Burst	Depends on the capacity of the memory. (no limit)
Self-timer	2 sec. / 10 sec. / Double
Flash	Auto / Red eye reduction / Always on / Slow sync / Always off
Photo effect	Black & White / Sepia / Negative / Mosaic / Red / Green / Blue
Storage	16 MB internal memory / SD Card 2GB/ SDHC 4 GB
TV system	NTSC / PAL
Power supply	2x AA rechargeable NiMH battery (option) 2x AA alkaline battery
Ambient temperature	Operating: 0° C to 40° C Storage: -20 to 60° C
Microphone	Built-in
Speaker	Built-in
Dimension	Camera Body (W x H x T) : 89.5 x 61.3 x 27 mm
Weight	Camera Body w/o battery : Approx. 120 (g)

*These specifications are subject to change without notice.

Function Available List

Function		Mode	Still Capture														
Shutter & Lens	Focus	One time AF	●	●	×	●	×	●	●	×	●	×	×	●	●	●	×
		Continuous AF	×	×	×	×	×	×	×	×	×	●	●	×	×	×	×
		Infinity Fixed	×	×	●	×	●	×	×	●	×	×	×	×	×	×	×
Shutter Speed			8-1/2000	1-1/2000	1-1/2000	1-1/2000	1-1/2000	1-1/2000	1-1/2000	2 sec. fixed.	8-1/2000	1-1/2000	1-1/2000	1-1/2000	1-1/2000	1/15-1/2000	×
Button	Macro	Off	●	●	●	●	●	●	●	●	●	○	●	×	●	×	
		On	○	○	×	×	×	×	×	×	×	×	●	×	●	○	×
	Flash	Auto	✓	○	×	×	×	×	●	×	×	×	●	●	×	×	×
		Red eye	○	○	×	×	×	●	×	×	×	●	×	×	×	×	×
		Force on	○	○	×	●	×	×	×	×	×	×	×	×	×	×	×
		Slow sync	○	○	×	×	×	×	×	×	●	×	×	×	×	×	×
Force off	○	○	●	○	●	○	○	●	○	○	○	○	●	×	×		
MENU	Resolution	8M	✓	○	○	○	○	○	○	○	○	○	○	○	○	×	×
		16:9	○	○	○	○	○	○	○	○	○	○	○	○	○	×	×
		3:2	○	○	○	○	○	○	○	○	○	○	○	○	○	×	×
		6M	○	○	○	○	○	○	○	○	○	○	○	○	○	×	×
		4M	○	○	○	○	○	○	○	○	○	○	○	○	○	×	×
		2M	○	○	○	○	○	○	○	○	○	○	○	○	○	×	×
		VGA	○	○	○	○	○	○	○	○	○	○	○	○	○	×	×
	Movie Size	16:9	×	×	×	×	×	×	×	×	×	×	×	×	×	○	×
		640	×	×	×	×	×	×	×	×	×	×	×	×	×	✓	×
		320	×	×	×	×	×	×	×	×	×	×	×	×	×	○	×
	Quality	S.Fine	○	●	○	○	○	○	○	○	○	○	○	○	○	×	×
		Fine	✓	×	○	○	○	○	○	○	○	○	○	○	○	×	×
		Normal	○	×	○	○	○	○	○	○	○	○	○	○	○	×	×
	Metering	Center	○	×	○	○	○	○	○	×	○	○	○	○	○	○	×
		Multi	✓	●	●	×	●	●	●	●	●	●	●	●	●	○	×
		Spot	○	×	×	●	×	×	×	×	×	×	×	×	×	○	×
	WB	Auto	✓	●	●	●	●	●	●	●	●	●	●	●	●	○	×
		Daylight	○	×	×	×	×	×	×	×	×	×	×	×	×	○	×
		Cloudy	○	×	×	×	×	×	×	×	×	×	×	×	×	○	×
		Tungsten	○	×	×	×	×	×	×	×	×	×	×	×	×	○	×
		Fluor_H	○	×	×	×	×	×	×	×	×	×	×	×	×	○	×
Fluor_L		○	×	×	×	×	×	×	×	×	×	×	×	×	○	×	
Custom		○	×	×	×	×	×	×	×	×	×	×	×	×	○	×	

Mode		Still Capture												Video	Audio		
		P	Portrait	Sunset	People	Landscapes	People	People	Party	Moon	Smile	Food	City			Document	
Function																	
		ISO	Auto	✓	●	●	●	●	●	●	●	●	×	●	●	●	●
50	○		×	×	×	×	×	×	×	×	●	×	×	×	×	×	×
100	○		×	×	×	×	×	×	×	×	×	×	×	×	×	×	×
200	○		×	×	×	×	×	×	×	×	×	×	×	×	×	×	×
400	○		×	×	×	×	×	×	×	×	×	×	×	×	×	×	×
Exposure	+0.3 ~ +2.0	○	×	×	×	×	×	×	×	×	×	×	×	×	×	×	×
	0.0	✓	●	●	●	●	●	●	●	●	●	●	●	●	●	×	×
	-0.3 ~ -2.0	○	×	×	×	×	×	×	×	×	×	×	×	×	×	×	×
Drive Mode (*)	Off	✓	○	○	○	○	○	○	○	○	○	○	○	○	○	×	×
	2 sec.	○	○	○	○	○	○	○	○	○	○	○	○	○	○	×	×
	10 sec.	○	○	○	○	○	○	○	○	○	○	○	○	○	○	×	×
	Double	○	○	○	○	○	○	○	○	○	○	○	○	○	○	×	×
	Burst	○	○	○	○	○	○	○	○	○	○	○	○	○	○	×	×
AEB	Off	●	●	●	●	●	●	●	●	●	●	●	●	●	●	×	×
	On	○	×	×	×	×	×	×	×	×	×	×	×	×	×	×	×
Highlight	Off	●	●	●	●	●	●	●	●	●	●	●	●	●	●	×	×
		○	×	×	×	×	×	×	×	×	×	×	×	×	×	×	×
		○	×	×	×	×	×	×	×	×	×	×	×	×	×	×	×
		○	×	×	×	×	×	×	×	×	×	×	×	×	×	×	×
Sharpness	Hard	○	×	●	×	●	×	×	×	×	×	×	●	×	×	×	×
	Normal	✓	●	×	●	×	●	●	●	●	●	●	×	●	×	×	×
	Soft	○	×	×	×	×	×	×	×	×	×	×	×	×	×	×	×
Effect	Off	●	●	●	●	●	●	●	●	●	●	●	●	●	×	×	
	B&W	○	×	×	×	○	○	×	×	×	×	○	○	○	×	×	×
	Sepia	○	×	×	×	○	○	×	×	×	×	○	○	○	×	×	×
	Negative	○	×	×	×	○	○	×	×	×	×	○	○	○	×	×	×
	Red	○	×	×	×	○	○	×	×	×	×	○	○	○	×	×	×
	Green	○	×	×	×	○	○	×	×	×	×	○	○	○	×	×	×
	Blue	○	×	×	×	○	○	×	×	×	×	○	○	○	×	×	×
Date Stamp	Off	✓	×	○	○	○	○	○	○	○	○	○	○	○	×	×	
	Date	○	×	○	○	○	○	○	○	○	○	○	○	○	×	×	
	Date & Time	○	●	○	○	○	○	○	○	○	○	○	○	○	×	×	
Digital Zoom	Off	○	●	○	○	○	○	○	○	○	○	○	○	○	×	×	
	On	✓	×	○	○	○	○	○	○	○	○	○	○	○	×	×	

✓: Factory setting ● : Default ○ : Available ✕ : Not available.

 : Setting is retained even after mode switch or power off.

(*): Set to [OFF] after power off.

Customer care

More information on the complete AgfaPhoto digital camera product range can be found under www.plawa.com

Service & Repair Hotline (Europe):

00800 752 921 00 (from a landline only)

Service & Support Hotline (Germany):

0900 1000 042 (1.49 Euro/ min. from a German landline only)

Online Service / International contact:

support-apdc@plawa.com

Manufactured by

plawa-feinwerktechnik GmbH & Co. KG

Bleichereistraße 18

73066 Uhingen

Germany

AgfaPhoto is used under license of Agfa-Gevaert NV & Co. KG. Agfa-Gevaert NV & Co. KG. does not manufacture this product or provide any product warranty or support. For service, support and warranty information, contact the distributor or manufacturer. Contact: AgfaPhoto Holding GmbH, www.agfaphoto.com

Disposal of Waste Equipment by Users in Private Households in the European Union



This symbol on the product or on its packaging indicates that this product must not be disposed of with your other household waste. Instead, it is your responsibility to dispose of your waste equipment by handing it over to a designated collection point for the recycling of waste electrical and electronic equipment. The separate collection and recycling of your waste equipment at the time of disposal will help to conserve natural resources and ensure that it is recycled in a manner that protects human health and the environment. For more information about where you can drop off your waste equipment for recycling, please

contact your local city office, your household waste disposal service or the shop where you purchased the product.

Batteries and rechargeable batteries should not be thrown in the trash can. Please return used batteries to the store or take it to where they collect such items. Following this guideline we are helping not to pollute our environment.

FCC Compliance and Advisory

This device complies with Part 15 of the FCC Rules. Operation is subject to the following two conditions: 1.) this device may not cause harmful interference, and 2.) this device must accept any interference received, including interference that may cause unsatisfactory operation. This equipment has been tested and found to comply with the limits for a Class B peripheral, pursuant to Part 15 of the FCC Rules. These limits are designed to provide reasonable protection against harmful interference in a residential installation. This equipment generates, uses, and can radiate radio frequency energy and, if not installed and used in accordance with the instructions, may cause harmful interference to radio communication. However, there is no guarantee that interference will not occur in a particular installation. If this equipment does cause harmful interference to radio or television reception, which can be determined by turning the equipment off and on, the user is encouraged to try to correct the interference by one or more of the following measures.

- Reorient or relocate the receiving antenna.
- Increase the separation between the equipment and receiver.
- Connect the equipment to an outlet on a circuit different from that to which the receiver is connected.
- Consult the dealer or an experienced radio/TV technician for help.

Any changes or modifications not expressly approved by the party responsible for compliance could void the user's authority to operate the equipment. When shielded interface cables have been provided with the product or when specified additional components or accessories have elsewhere been designated to be used with the installation of the product, they must be used in order to ensure compliance with FCC regulations.